

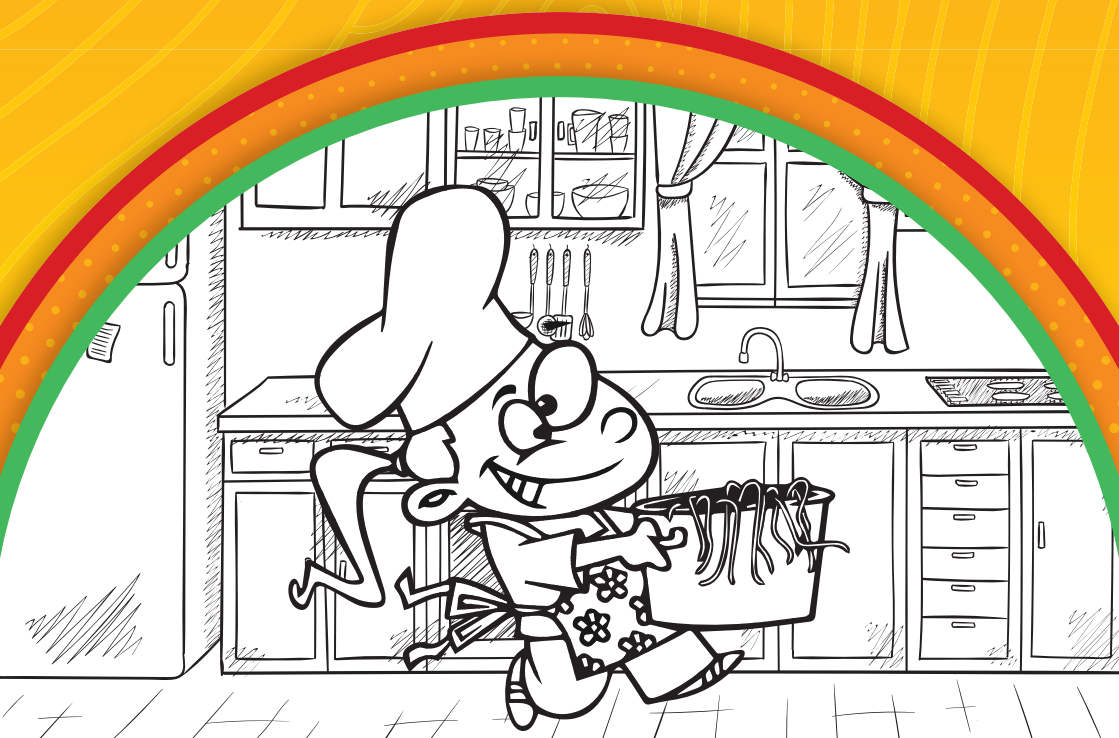

POLANA KIDS PLAYBOOK

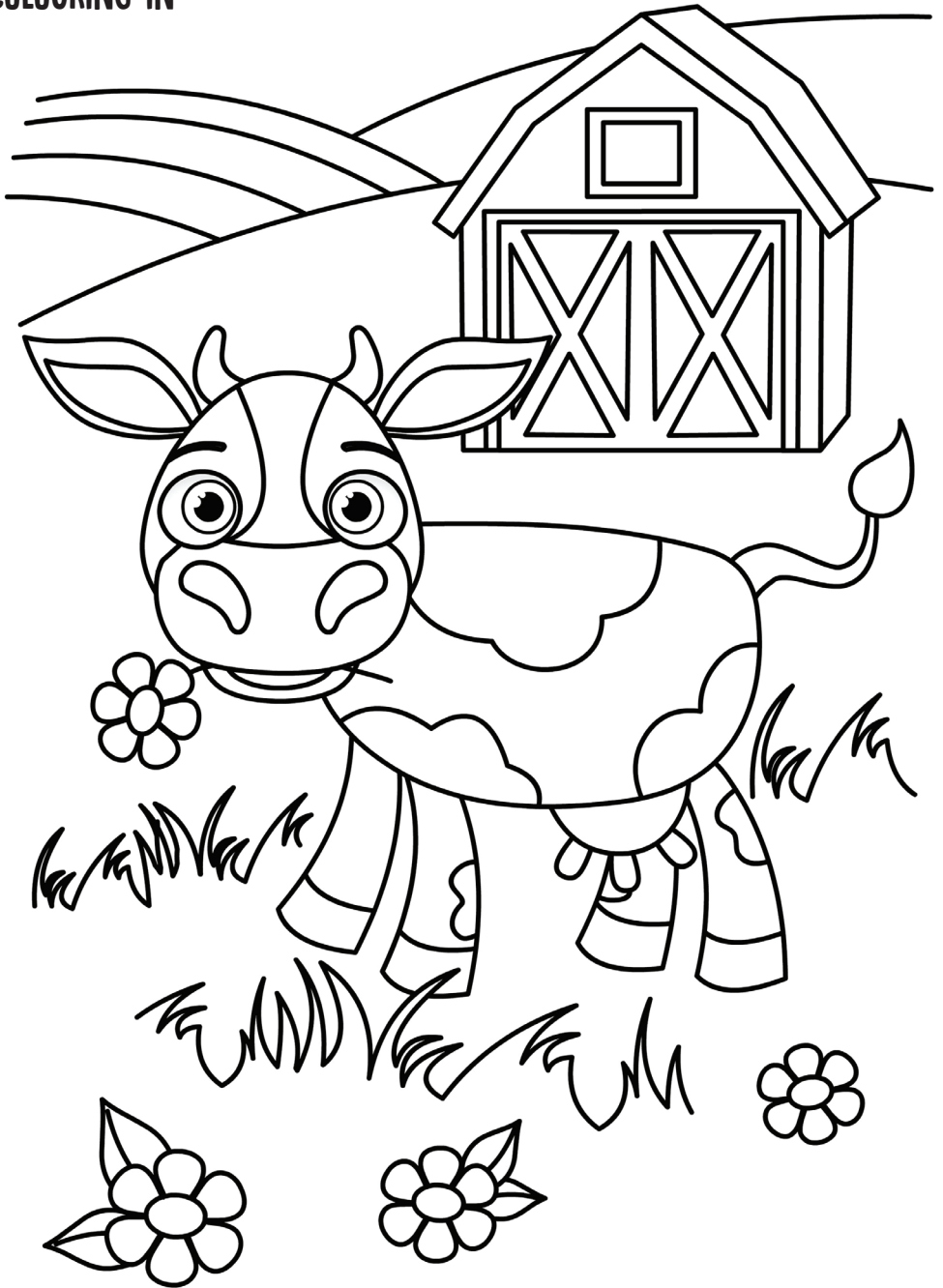

COLOURING IN



GET TO THE CENTRE



COLOUR BY NUMBER



BLUE



LIGHT BLUE



YELLOW



BROWN



ORANGE



GREEN



RED

CONNECT THE DOTS

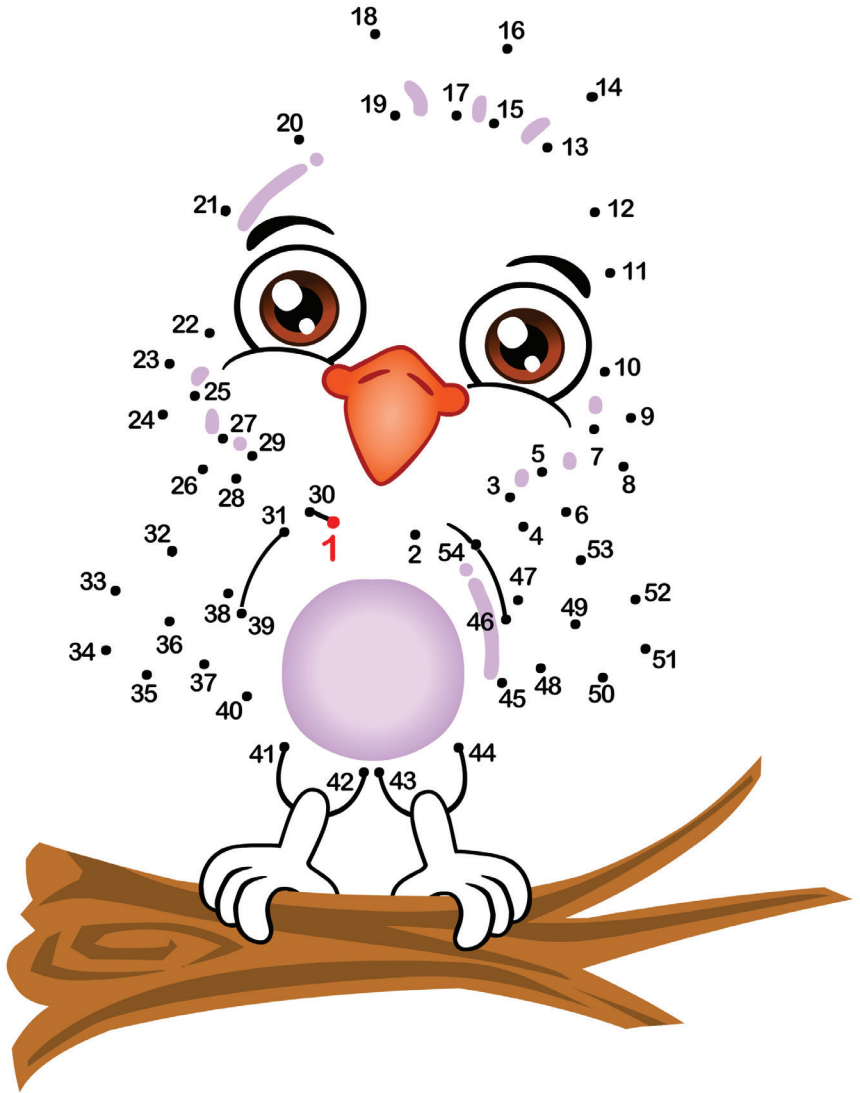

DRAW THE OTHER HALF

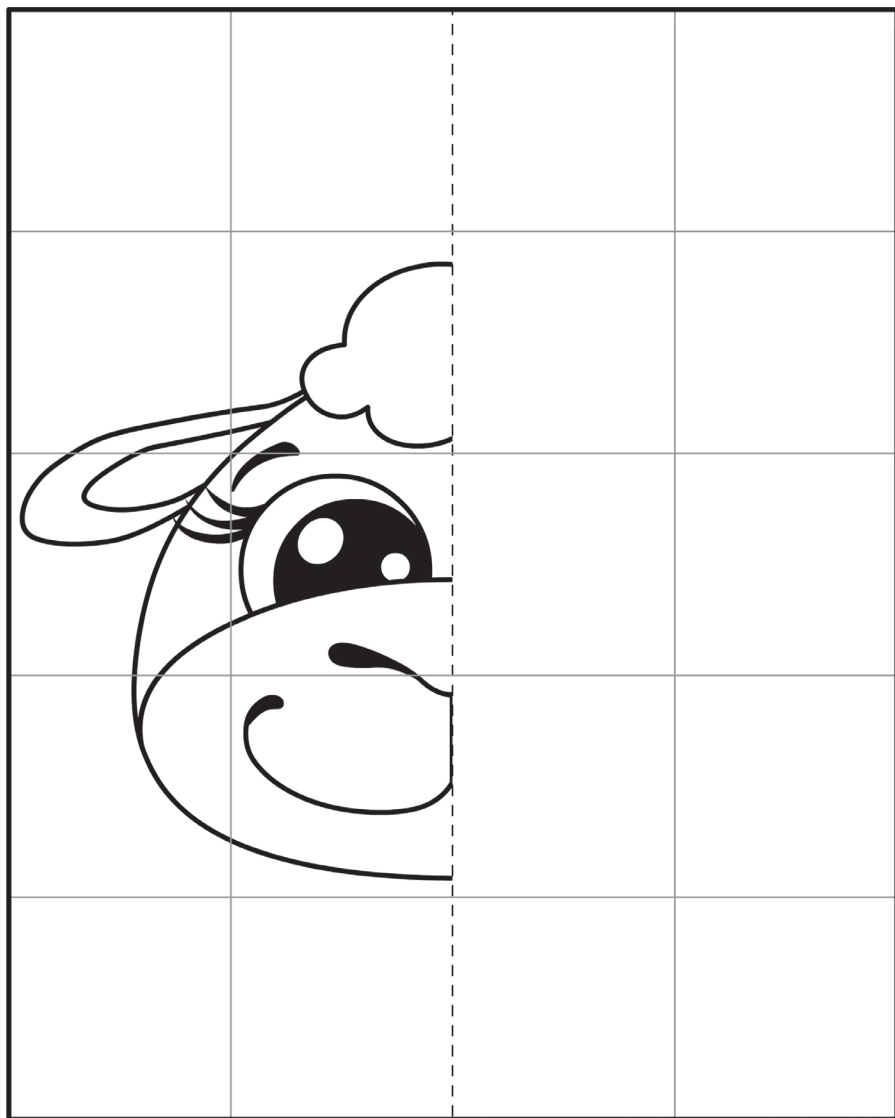

SIMPLE SUDOKU

	8	9			5	1	4	
3			8	1	7			6
7	1		6		4	3	8	
	4	3	9					
9	7						1	4
					8	7	3	
	9	6	4		2		7	1
4			1	5	9			2
	2	1	7			4	9	

WORD SEARCH

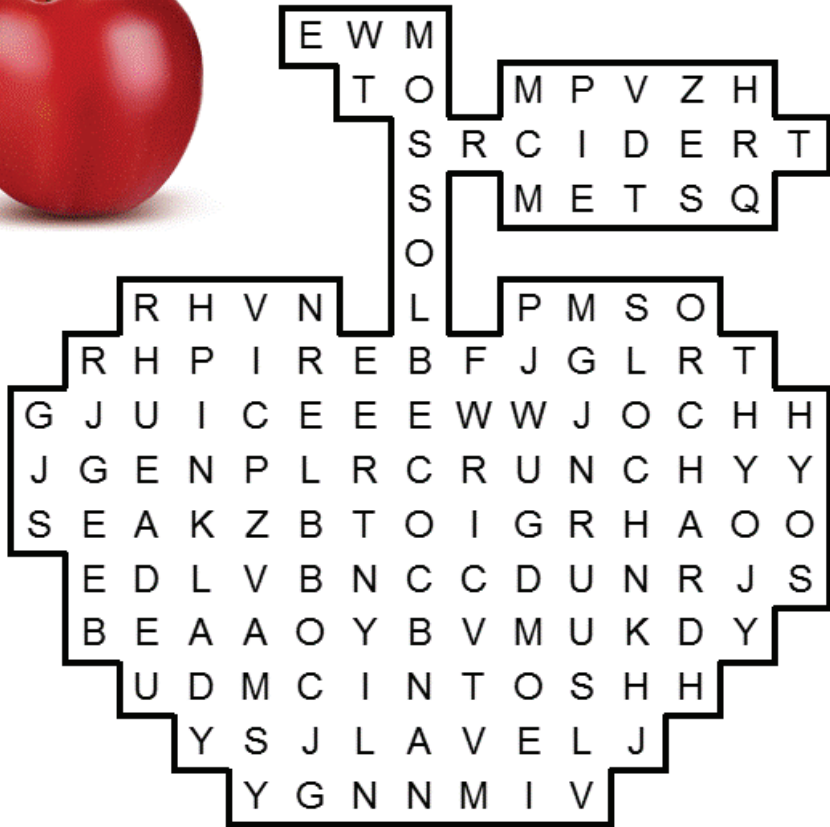

BLOSSOM
CIDER
COBBLER
CORE
CRUNCHY
GALA
GREEN

JUICE
JUICY
MCINTOSH
ORCHARD
PEEL
PIE
PINK LADY

RED
SEEDS
STEM
TREE
WORM

COLOURING IN



GET TO THE FINISH

START

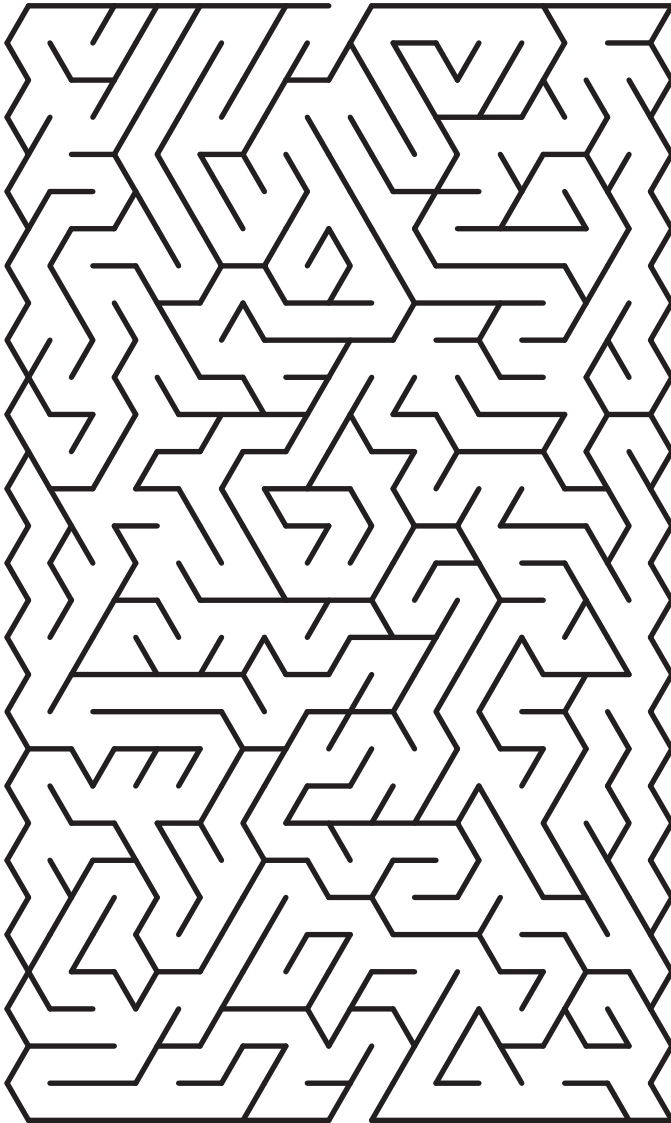

FINISH

COLOUR BY NUMBER

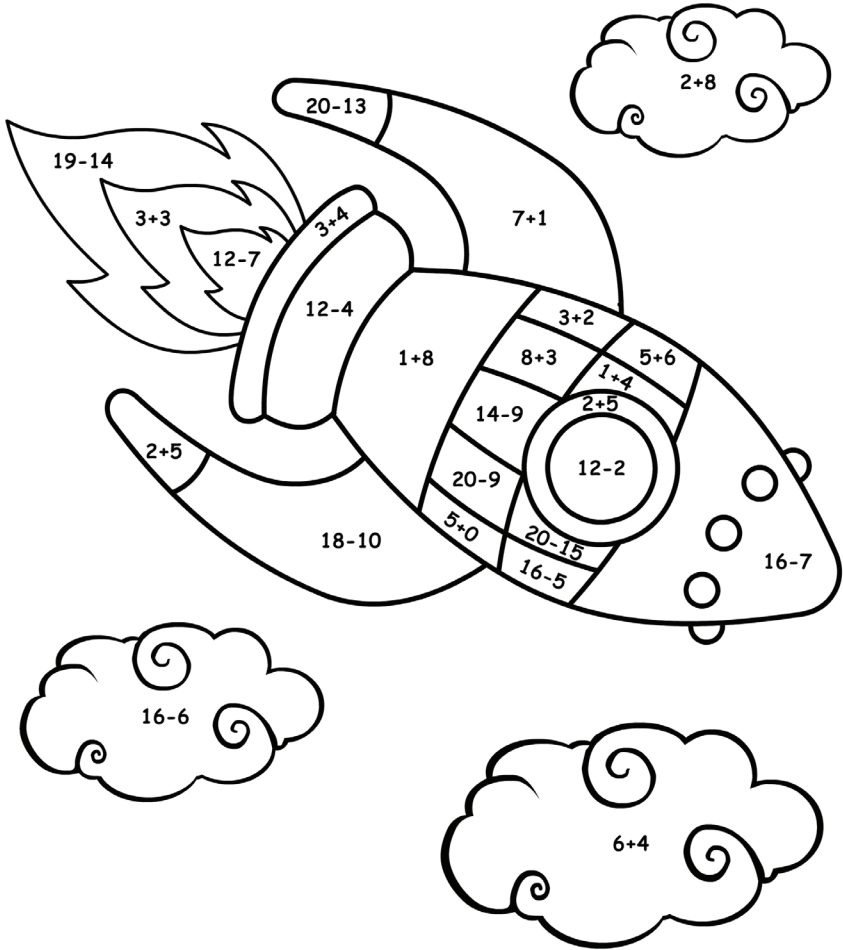

YELLOW



ORANGE



RED



PURPLE



PINK



BLUE



GREEN

CONNECT THE DOTS

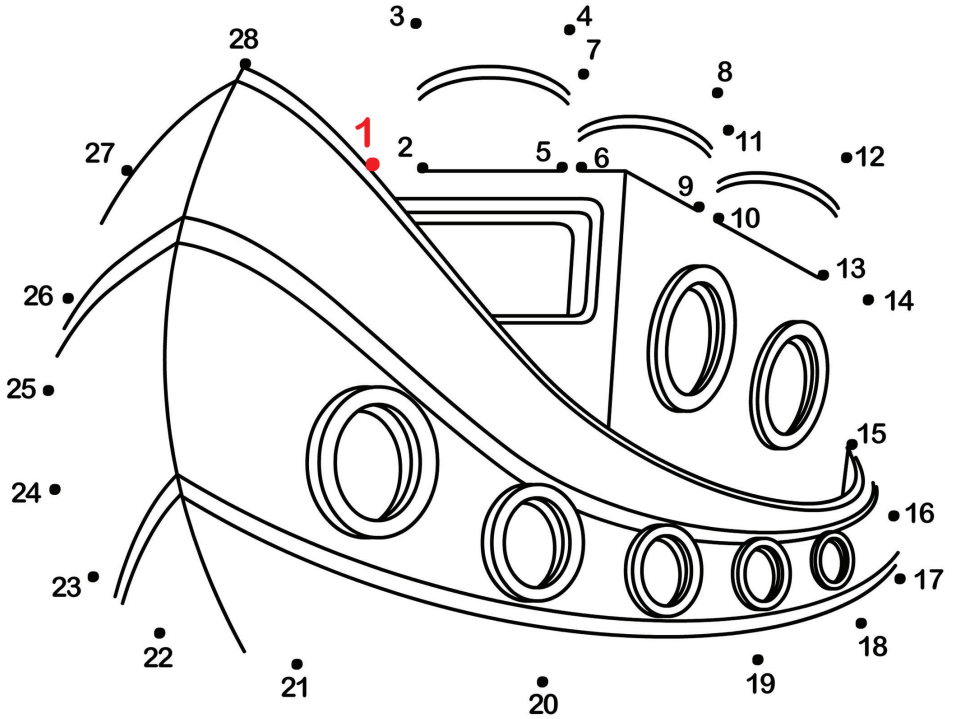

WORD SEARCH

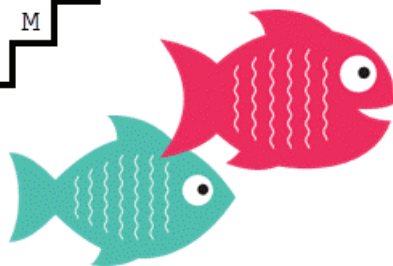
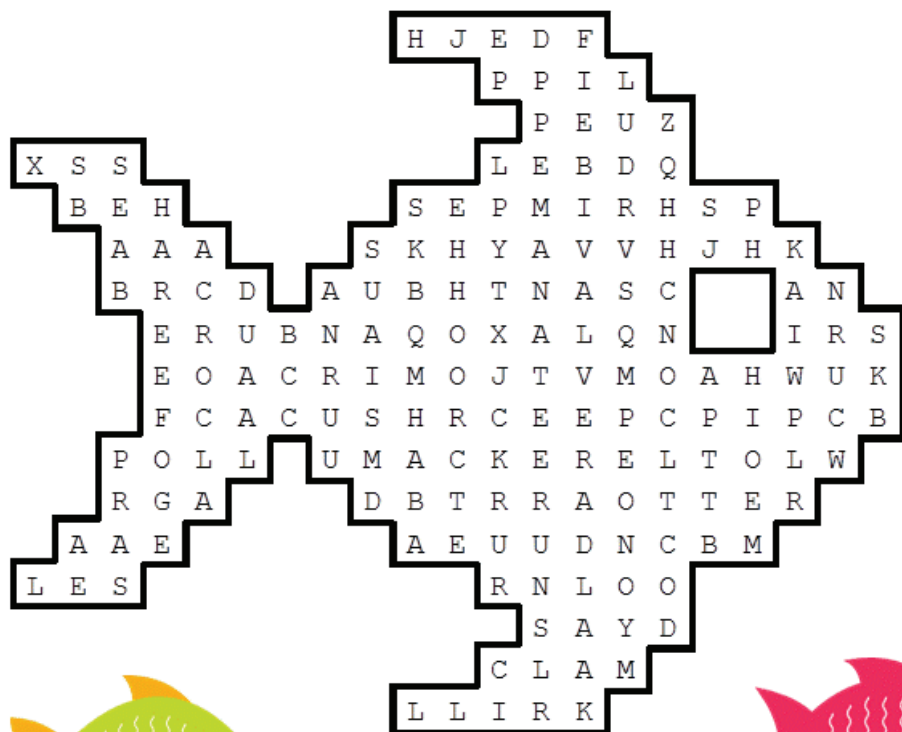

ALGAE
BARRACUDA
BASS
BIVALVE
CLAM
COD
CONCH
CORAL
CRAB
DIATOMS
DOLPHIN

EEL
KELP
KRILL
MACKEREL
MANATEE
OCEAN
OCTOPUS
ORCA
OTTER
RAY
REEF

SEA CUCUMBER
SEAL
SHAD
SHARK
SHRIMP
SQUID
TUNA
URCHIN

SIMPLE SUDOKU

9	8	3	4		7		2	
	6	1						4
				6				
5				8	3	9		6
1		6		4		2		8
8		9	7	1				3
				9				
6						1	8	
	5		1		2	3	6	9

COLOURING IN



POLANA KIDS PLAYBOOK

